

Neutralizes static charges at long distances
without the aid of compressed air



LR-HVLE

High voltage unit for LR-LE emitters.

- 4 outputs: 2 positive (+), 2 negative (-).
- Cable length per output: ≤ 6 meters.
- Input voltage: 24VDC.
- Output voltage: 16kV, pulsed DC.
- Adjustable pulse frequency.

LR-LE

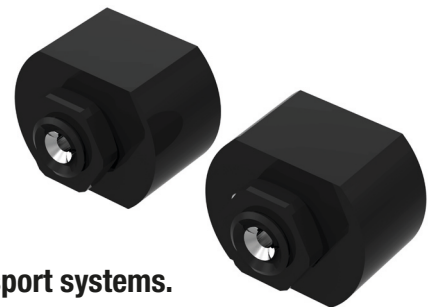

Compact emitter for installation on machines and in transport systems.

- Flexible installation and positioning.
- Installation in small spaces.
- Durable and easy maintenance.
- Machined from PVC.

Dimensions

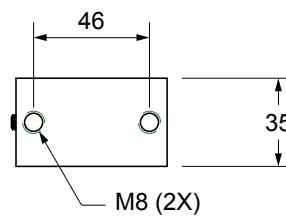
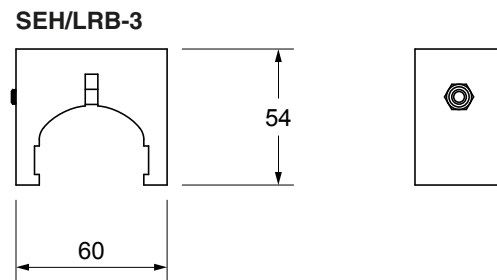
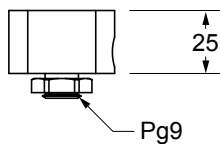
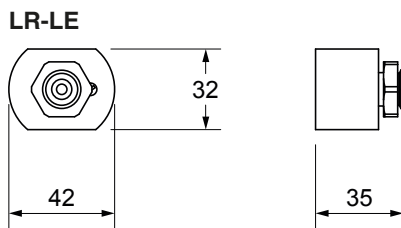
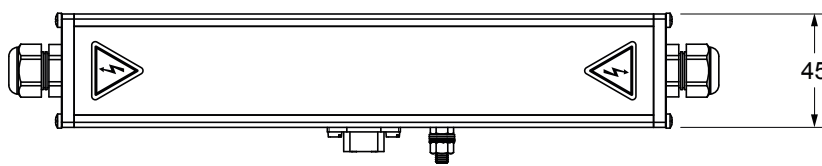
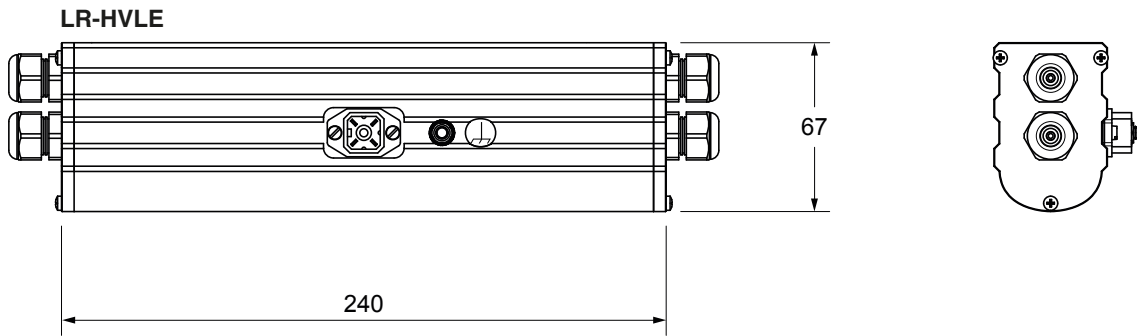

Parts List

LR-HVLE High Voltage Generator

Order No.: LI 03 01 74

LR-LE Ionizing Emitter with Cable

2 m, Order No.: LI 04 01 01

SEH/LRB-3 Mounting Bracket

Order No.: LI 01 90 05

SKLR/04 Signal Cable

5 m, Order No.: LI 02 04 05

10 m, Order No.: LI 02 04 10

25 m, Order No.: LI 02 04 25

